





Standartinis ortakio ilgis L = 3000 mm
Kaina Eur/m be PVM



Apvalūs ortakiai

Ø, mm	Skardos storis, mm	Mato vnt.	Kaina EUR, be PVM	
100	0,5	m	2,50	*
125	0,5	m	3,16	*
160	0,5	m	4,08	*
200	0,5	m	5,21	*
250	0,5	m	6,24	*
315	0,6	m	8,25	*
355	0,6	m	11,70	
400	0,6	m	14,14	
450	0,8	m		
500	0,8	m		
630	0,8	m		

* sandėliuojami gaminiai



UAB "EOS" pasilieka teisę keisti kainas be atskiro įspėjimo.



Alkūnės su sandarinimo gumomis
Kaina Eur/vnt. be PVM





Alkūnė 45 laipsnių

Ø, mm	Skardos storis, mm	Mato vnt.	Kaina EUR, be PVM
100	0,55	vnt	3,65 *
125	0,55	vnt	4,16 *
160	0,55	vnt	5,20 *
200	0,55	vnt	7,46 *
250	0,55	vnt	8,92 *
315	0,55	vnt	12,85 *
400	0,70	vnt	
500	0,70	vnt	

* sandėliuojami gaminiai

Alkūnė 90 laipsnių

Ø, mm	Skardos storis, mm	Mato vnt.	Kaina EUR, be PVM
100	0,55	vnt	4,24 *
125	0,55	vnt	5,07 *
160	0,55	vnt	7,51 *
200	0,55	vnt	9,41 *
250	0,55	vnt	10,87 *
315	0,55	vnt	16,96 *
400	0,70	vnt	
500	0,70	vnt	

* sandėliuojami gaminiai

UAB "EOS" pasilieka teisę keisti kainas be atskiro įspėjimo.



Movos su sandarinimo gumomis
Kaina Eur/vnt. be PVM

**Movos**

Ø, mm	Skardos storis, mm	Mato vnt.	Kaina EUR, be PVM	
100	0,55	vnt	1,58	*
125	0,55	vnt	1,58	*
160	0,55	vnt	1,81	*
200	0,55	vnt	2,53	*
250	0,55	vnt	3,78	*
315	0,55	vnt	4,19	*
400	0,70	vnt		
500	0,70	vnt		

* sandėliuojami gaminiai

UAB "EOS" pasilieka teisę keisti kainas be atskiro įspėjimo.



Balnai su sandarinimo gumomis
Kaina Eur/vnt. be PVM



Balnai

Ø, mm	Skardos storis, mm	Mato vnt.	Kaina EUR, be PVM	
Balnas BAU 100-100	0,55	vnt	2,34	*
Balnas BAU 125-100	0,55	vnt	2,34	*
Balnas BAU 125-125	0,55	vnt	2,56	*
Balnas BAU 160-100	0,55	vnt	2,21	*
Balnas BAU 160-125	0,55	vnt	2,98	*
Balnas BAU 160-160	0,55	vnt	3,90	*
Balnas BAU 200-100	0,55	vnt	2,50	*
Balnas BAU 200-125	0,55	vnt	2,84	*
Balnas BAU 200-160	0,55	vnt	3,85	*
Balnas BAU 200-200	0,55	vnt	5,44	*
Balnas BAU 250-100	0,55	vnt	2,88	*
Balnas BAU 250-125	0,55	vnt	2,98	*
Balnas BAU 250-160	0,55	vnt	3,90	*
Balnas BAU 250-200	0,55	vnt	5,76	*
Balnas BAU 250-250	0,55	vnt	7,11	*
Balnas BAU 315-100	0,55	vnt	3,56	*
Balnas BAU 315-125	0,55	vnt	3,46	*
Balnas BAU 315-160	0,55	vnt	4,85	*
Balnas BAU 315-200	0,55	vnt	6,30	*
Balnas BAU 315-250	0,55	vnt	7,73	*
Balnas BAU 315-315	0,55	vnt	10,99	*
Balnas BAU 400-160	0,70	vnt		
Balnas BAU 400-200	0,70	vnt		
Balnas BAU 400-250	0,70	vnt		
Balnas BAU 400-315	0,70	vnt		
Balnas BAU 400-400	0,70	vnt		

* sandėliuojami gaminiai

UAB "EOS" pasilieka teisę keisti kainas be atskiro įspėjimo.



Aklės su sandarinimo guma
Kaina Eur/vnt. be PVM

**Aklės**

Ø, mm	Skardos storis, mm	Mato vnt.	Kaina EUR, be PVM
100	0,55	vnt	2,81
125	0,55	vnt	2,85
160	0,55	vnt	3,46
200	0,55	vnt	3,85
250	0,55	vnt	5,70
315	0,55	vnt	6,80
400	0,60	vnt	
500	0,60	vnt	

* sandėliuojami gaminiai

UAB "EOS" pasilieka teisę keisti kainas be atskiro įspėjimo.



Aklės su sandarinimo guma
Kaina Eur/vnt. be PVM

**Aklės**

Ø, mm	Skardos storis, mm	Mato vnt.	Kaina EUR, be PVM
100	0,55	vnt	2,97
125	0,55	vnt	3,20
160	0,55	vnt	4,85
200	0,55	vnt	5,00
250	0,55	vnt	8,80
315	0,55	vnt	11,20
400	0,60	vnt	
500	0,60	vnt	

* sandėliuojami gaminiai

UAB "EOS" pasilieka teisę keisti kainas be atskiro įspėjimo.



Perėjimai centruoti/išcentruoti su sandarinimo gumomis
Kaina Eur/vnt. be PVM



Perėjimai centruoti/išcentruoti

Ø, mm	Skardos storis, mm	Mato vnt.	Kaina EUR, be PVM
Perėjimas RCLU 125-100	0,55	vnt	3,80
Perėjimas RCLU 160-100	0,55	vnt	3,92
Perėjimas RCLU 160-125	0,55	vnt	3,92
Perėjimas RCLU 200-100	0,55	vnt	4,93
Perėjimas RCLU 200-125	0,55	vnt	4,93
Perėjimas RCLU 200-160	0,55	vnt	5,36
Perėjimas RCLU 250-100	0,55	vnt	
Perėjimas RCLU 250-125	0,55	vnt	7,80
Perėjimas RCLU 250-160	0,55	vnt	6,90
Perėjimas RCLU 250-200	0,55	vnt	7,47
Perėjimas RCLU 315-125	0,55	vnt	12,70
Perėjimas RCLU 315-160	0,55	vnt	12,00
Perėjimas RCLU 315-200	0,55	vnt	9,71
Perėjimas RCLU 315-250	0,55	vnt	11,36
Perėjimas RCLU virš Ø315			
Perėjimas RLU 125-100	0,55	vnt	5,75
Perėjimas RLU 160-100	0,55	vnt	6,90
Perėjimas RLU 160-125	0,55	vnt	7,29
Perėjimas RLU 200-100	0,55	vnt	9,50
Perėjimas RLU 200-125	0,55	vnt	8,50
Perėjimas RLU 200-160	0,55	vnt	8,70
Perėjimas RLU 250-100	0,55	vnt	9,50
Perėjimas RLU 250-125	0,55	vnt	8,50
Perėjimas RLU 250-160	0,55	vnt	8,50
Perėjimas RLU 250-200	0,55	vnt	11,20
Perėjimas RLU 315-125	0,55	vnt	
Perėjimas RLU 315-160	0,55	vnt	15,50
Perėjimas RLU 315-200	0,55	vnt	13,95
Perėjimas RLU 315-250	0,55	vnt	14,32
Perėjimas RLU virš Ø315			

* sandėliuojami gaminiai

UAB "EOS" pasilieka teisę keisti kainas be atskiro įspėjimo.



Tiesios atšakos su sandarinimo gumomis
Kaina Eur/vnt. be PVM



Tiesios atšakos

Ø, mm	Skardos storis, mm	Mato vnt.	Kaina EUR, be PVM
100	0,55	vnt	1,91
125	0,55	vnt	2,03
160	0,55	vnt	2,43
200	0,55	vnt	3,63
250	0,55	vnt	4,26
315	0,55	vnt	4,96
400	0,60	vnt	
500	0,60	vnt	

* sandėliuojami gaminiai

UAB "EOS" pasilieka teisę keisti kainas be atskiro įspėjimo.



Trišakiai su sandarinimo gumomis
Kaina Eur/vnt. be PVM

**Tiesios atšakos**

Ø, mm	Skardos storis, mm	Mato vnt.	Kaina EUR, be PVM	
100/100	0,50	vnt	5,59	*
125/100	0,60	vnt	6,05	*
125/125	0,70	vnt	6,42	*
160/100	0,70	vnt	6,93	*
160/125	0,80	vnt	7,85	*
160/160	1,20	vnt	9,68	*
200/160	1,20	vnt	9,90	*
200/200	1,40	vnt	11,13	*

* sandėliuojami gaminiai

UAB "EOS" pasilieka teisę keisti kainas be atskiro įspėjimo.



Kryžmės su sandarinimo gumomis
Kaina Eur/vnt. be PVM

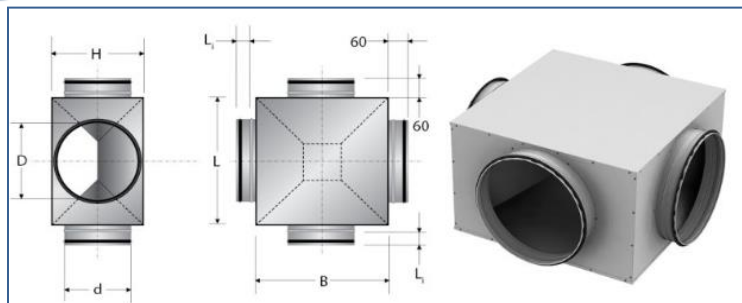

Tiesios atšakos

Ø, mm	Skardos storis, mm	Mato vnt.	Kaina EUR, be PVM
100/100	1,40	vnt	65,00 *
125/100	1,80	vnt	70,00 *
125/125	1,80	vnt	73,00 *
160/100	2,50	vnt	73,00 *
160/125	2,50	vnt	76,00 *
160/160	2,60	vnt	78,00
200/100	3,30	vnt	81,00
200/125	3,30	vnt	84,00

* sandėliuojami gaminiai

UAB "EOS" pasilieka teisę keisti kainas be atskiro įspėjimo.



Stogeliai su sandarinimo gumomis
Kaina Eur/vnt. be PVM



Stogeliai

Ø, mm	Skardos storis, mm	Mato vnt.	Kaina EUR, be PVM
100	0,55	vnt	10,95
125	0,55	vnt	12,10
160	0,55	vnt	14,65
200	0,55	vnt	18,70
250	0,55	vnt	25,75
315	0,55	vnt	33,20
400	0,60	vnt	
500	0,60	vnt	

* sandėliuojami gaminiai

UAB "EOS" pasilieka teisę keisti kainas be atskiro įspėjimo.

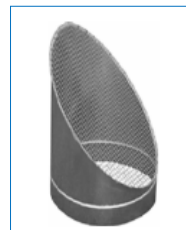

Antgaliai su tinkleliu
Kaina Eur/vnt. be PVM

**Antgaliai**

Ø, mm	Skardos storis, mm	Mato vnt.	Kaina EUR, be PVM
100	0,55	vnt	
125	0,55	vnt	9,36 *
160	0,55	vnt	9,56 *
200	0,55	vnt	10,56 *
250	0,55	vnt	13,72 *
315	0,55	vnt	21,72 *
400	0,60	vnt	
500	0,60	vnt	

* sandėliuojami gaminiai

UAB "EOS" pasilieka teisę keisti kainas be atskiro įspėjimo.



Difuzoriai DVS-skirti orui ištraukti, P-DVS-skirti orui paduoti
Kaina Eur/vnt. be PVM

**Difuzoriai DVS, P-DVS**

Ø, mm	Svoris, kg	Mato vnt.	Kaina EUR, be PVM	
100	0,30	vnt	3,22	*
125	0,44	vnt	3,86	*
160	0,60	vnt	4,53	*
200	0,80	vnt	6,57	*
250	0,80	vnt		

* sandėliuojami gaminiai, pagaminta Olandijoje

UAB "EOS" pasilieka teisę keisti kainas be atskiro įspėjimo.



i Rankinio reguliavimo, atbulinės traukos ir IRIS sklendės
Kaina Eur/vnt. be PVM



Rankinio reguliavimo sklendės RRS

Ø, mm	Svoris, kg	Mato vnt.	Kaina EUR, be PVM	
100	0,33	vnt	7,92	*
125	0,37	vnt	8,02	*
160	0,54	vnt	8,85	*
200	0,59	vnt	9,44	*
250	0,98	vnt	10,40	*
315	1,12	vnt	15,13	*
400	1,50	vnt		
500	1,80	vnt		

Atbulinės traukos sklendės ATS

Ø, mm	Svoris, kg	Mato vnt.	Kaina EUR, be PVM	
100	0,13	vnt	4,21	*
125	0,17	vnt	4,58	*
160	0,24	vnt	5,12	*
200	0,29	vnt	6,00	*
250	0,68	vnt	8,06	*
315	0,81	vnt	9,94	*
400	1,68	vnt	26,43	*

Skvendės IRIS

Ø, mm	Svoris, kg	Mato vnt.	Kaina EUR, be PVM
100	0,13	vnt	21,10
125	0,17	vnt	22,15
160	0,24	vnt	29,90
200	0,29	vnt	34,36
250	0,68	vnt	44,66
315	0,81	vnt	57,86

* sandėliuojami gaminiai

**didesnio diametro teirautis atskiru užklausu

UAB "EOS" pasilieka teisę keisti kainas be atskiro įspėjimo.



Sferinės lauko grotelės - burbuliukas
Kaina Eur/vnt. be PVM

**Lauko grotos**

Ø, mm	Svoris, kg	Mato vnt.	Kaina EUR, be PVM	
100	-	vnt	14,20	*
125	-	vnt	15,89	*
160	-	vnt	18,79	*
200	-	vnt	22,69	*

* sandėliuojami gaminiai

UAB "EOS" pasilieka teisę keisti kainas be atskiro įspėjimo.



Lauko grotos KWO montuojamos ant išorinės sienos
Kaina Eur/vnt. be PVM

**Lauko grotos**

Ø, mm	Svoris, kg	Mato vnt.	Kaina EUR, be PVM	
100	0,10	vnt	4,52	*
125	0,18	vnt	5,35	*
160	0,30	vnt	7,85	*
200	0,50	vnt	10,79	*
250	1,00	vnt	21,53	*
315	1,50	vnt	31,70	*

* sandėliuojami gaminiai

**didesnio diametro teirautis atskiru užklausimu

UAB "EOS" pasilieka teisę keisti kainas be atskiro įspėjimo.



Lankstūs ortakiai ALUDEC/COMBIDEC - nešiltintas, SONODEC - šiltintas
Kaina Eur/dėžė be PVM



Lankstūs ortakiai ALUDEC**

Ø, mm	Svoris, kg	Mato vnt.	Kaina EUR, be PVM	
102	2,00	dėžė	18,95	*
127	2,50	dėžė	22,64	*
160	3,00	dėžė	29,25	*
203	4,00	dėžė	36,90	*
254	6,00	dėžė	45,21	*
315	8,20	dėžė	55,04	*

Lankstūs ortakiai COMBIDEC**

Ø, mm	Svoris, kg	Mato vnt.	Kaina EUR, be PVM	
102	2,00	dėžė	19,95	*
127	2,50	dėžė	21,64	*
160	3,00	dėžė	25,50	*
200	4,00	dėžė	34,90	
250	6,00	dėžė	42,30	
315	8,20	dėžė		

Lankstūs ortakiai SONODEC**

Ø, mm	Svoris, kg	Mato vnt.	Kaina EUR, be PVM	
102	0,50	dėžė	29,48	*
127	0,60	dėžė	33,64	*
165	0,70	dėžė	38,43	*
203	0,90	dėžė	45,37	*
254	1,00	dėžė	57,65	*
315	1,50	dėžė	69,65	*

* sandėliuojami gaminiai, pagaminta Olandijoje

**Dėžėje 10 m, temperatūra: -30°C - +140°C

UAB "EOS" pasilieka teisę keisti kainas be atskiro įspėjimo.





Priedai montavimui
Kaina Eur be PVM



Priedai montavimui

Prekė/Tipas	Mato vnt.	Kaina EUR, be PVM	Nuotrauka
Savisriegiai 13 mm ilgio	1 dėžė (1000 vnt.)	10,93	 *
Savisriegiai 16 mm ilgio	1 dėžė (1000 vnt.)	12,08	 *
Izoliacija COROPLAST 50mmx100m	1 vnt.	12,50	 *
Izoliacija COROPLAST 75mmx100m	1 vnt.	19,80	 *
Izoliacija COROPLAST 100mmx100m	1 vnt.	24,90	 *
Mineralinės vatos demblys Ventilam (klijuojamas) 30mm 8,0 m2	1 pak.	38,20	 *
Mineralinės vatos demblys Ventilam (klijuojamas) 50mm 5,0 m2	1 pak.	39,05	 *
Kalamas ankeris M08 1 dėžė (100 vnt.)	1 vnt.	0,17	 *
Kalamas ankeris M10 1 dėžė (100 vnt.)	1 vnt.	0,23	 *
Žalvarinis ankeris M08 1 dėžė (100 vnt.)	1 vnt.	0,22	 *
K-Flex 19mm klijuojamas, 10,0m2	1 m2	11,94	 *

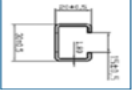
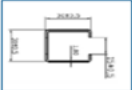
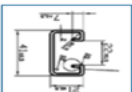
Sąvarža neiloninė L- 550 MM	1 vnt.	0,25		*
Sąvarža neiloninė L- 800 MM	1 vnt.	0,38		*
Sąvarža neiloninė L- 1188 MM	1 vnt.	0,57		*
Laikiklis L	1 vnt.	0,46		
Laikiklis Z	1 vnt.	0,39	*	
Laikiklis V	1 vnt.	0,67	*	
Srieginis strypas M8x2000	1 vnt.	1,12		*
Srieginis strypas M10x2000	1 vnt.	1,74		*
Varžtas M8x25 mm	1 vnt.			
Varžtas M10x25 mm	1 vnt.			
Veržlė M8	1 vnt.			
Veržlė M10	1 vnt.			
Poveržlė M8	1 vnt.			
Poveržlė M10	1 vnt.			
Lipnūs vinys SC 32mm	1 vnt.	0,11		
Lipnūs vinys SC 51mm	1 vnt.	0,13		
Lipnūs vinys SC 63mm	1 vnt.	0,15		
Lipnūs vinys SC 76mm	1 vnt.	0,17		
Lipnūs vinys SC 89mm	1 vnt.	0,19		
Lipnūs vinys SC 105mm	1 vnt.	0,22		
Virinami vinys 20mm	1 vnt.	0,08		
Virinami vinys 32mm	1 vnt.	0,09		
Virinami vinys 50mm	1 vnt.	0,15		
Virinami vinys 63mm	1 vnt.	0,17		
Virinami vinys 80mm	1 vnt.	0,19		
Virinami vinys 105mm	1 vnt.	0,22		

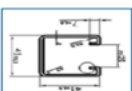
Profilis U 30-20, 2300 mm	1 vnt.	4,87	U 30-20		*
Profilis U 30-30, 2300 mm	1 vnt.	6,16	U 30-30		*
Profilis U 41-21, 2300 mm	1 vnt.	10,09	U 41-21		*
Profilis U 41-41, 2000 mm	1 vnt.		U 41-41		*
Profilis U 41-41, 3000 mm	1 vnt.	19,55	U 41-41		*

* sandėliuojami gaminiai

UAB "EOS" pasilieka teisę keisti kainas be atskiro įspėjimo.

info@eos.lt